

Article number: 03551040

Description: Fluro hydraulic rod end FPR 40CE

Measures

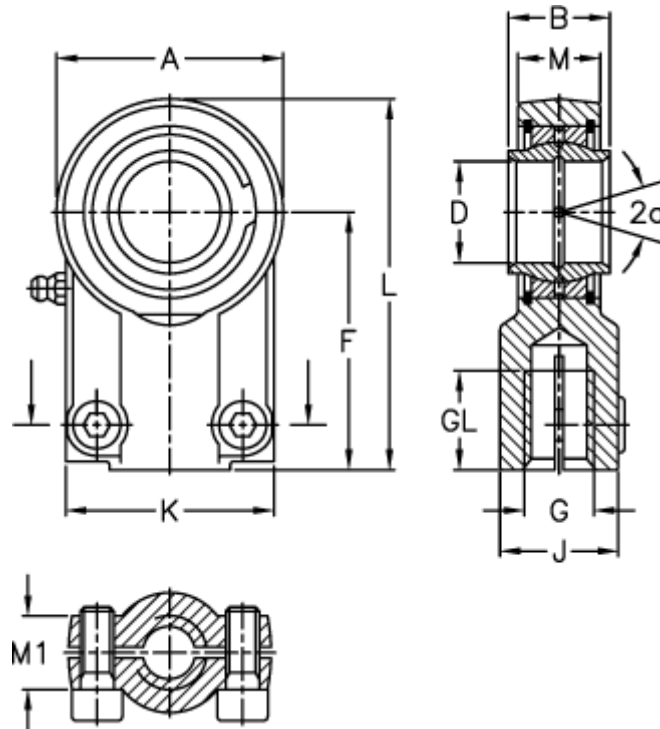

A	= 90	J	= 47
a (degrees)	= 4	K	= 80
B	= 40	L	= 146.1
D	= 40	M	= 33
Dynamic load C (kN)	= 100	M1	= 26
F	= 97	Static load C0 (kN)	= 204
g	= M33x2	Torque (N m)	= 49
GL	= 46	Weight	= 2150